



TROUBLESHOOT GUIDELINE

Contents

3 Charge Device

5 Can't Charge Device

10 LED Problem

15 Cleaning

17 Leaking

22 Burning Sensation

26 Charging NCASE

28 Can't Charge NCASE

3

Charge Device

Charge Device

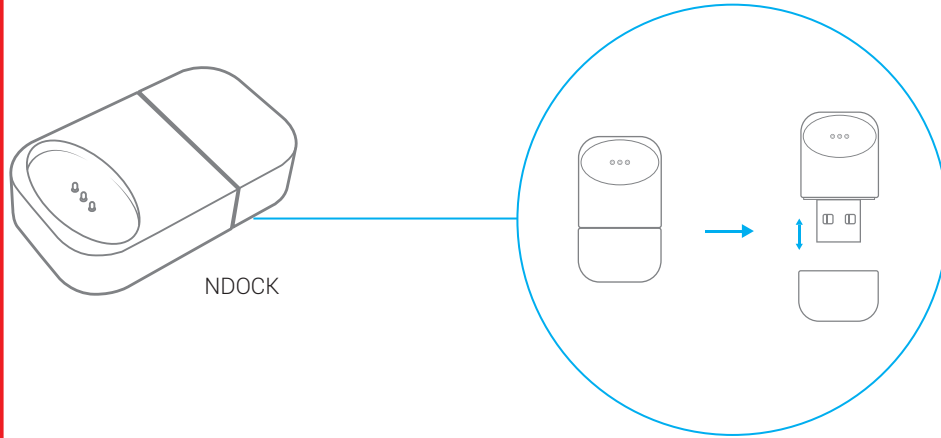

How to charge

Step 1

Plug the USB Charging Dock into a **USB port**. A laptop USB port is ideal (5V 0.5A)

You can use a wall outlet (5V 0.5A, 1.0A, 1.5A and 2A) like the ones you would use to connect to your phone charging cord.

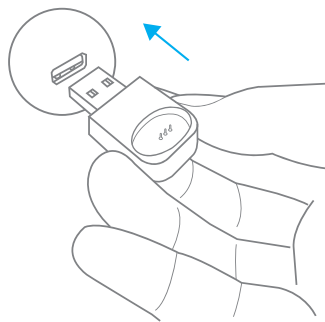

Step 2

Place the **NDOCK** into the USB Charging Dock.

The magnets in the NCIG Device will hold it in place while it's charging.

You can still charge your NCIG with an NPOD attached into the device.

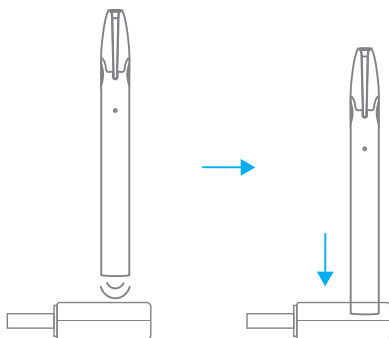

5

Can't Charge Device

Can't Charge Device

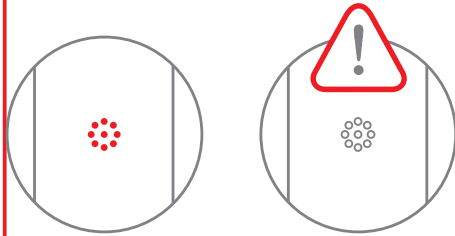

User

Step 1

When your NCIG Device is charging, a RED colour light will appear when connected to the USB Charging Dock. If the LED light does not show, try the following steps:

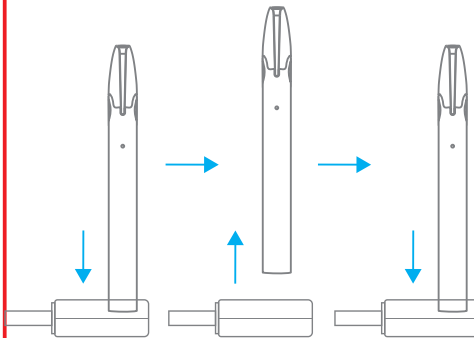

- 1 Plug in and Plug out the NCIG device to see if it makes a clear connection to the USB Cable

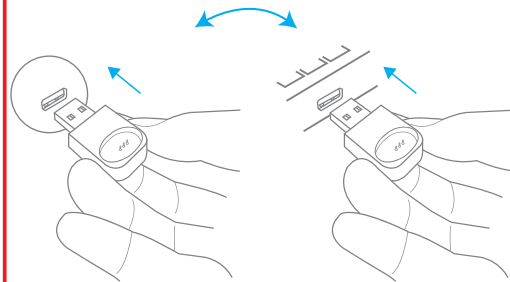

- 2 Switch to a different power source, either a USB wall adapter or a laptop USB port.

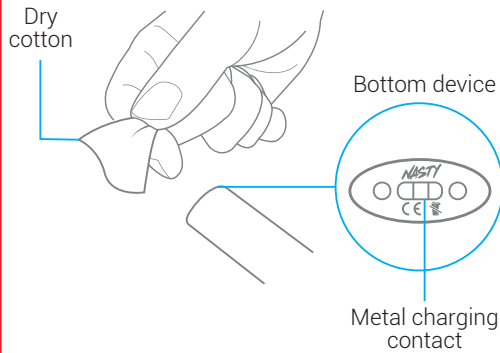

3 In case of residue, gently clean the metal charge contacts on the bottom of your NCIG device and the USB Charging Dock with a dry cotton swab.

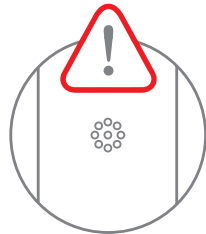

Step 2

If your NCIG Device is still not charging (no change in LED indicator) and is within the warranty period, please submit a warranty claim for a device replacement.

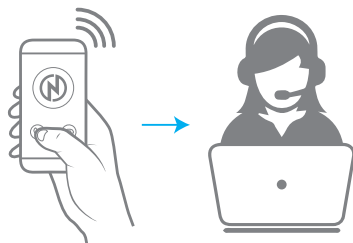

Step 3

Please report to our customer service. Proceed with your details and information, and save your ticket number.

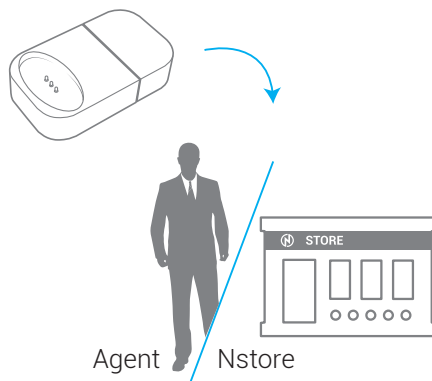

Step 4

Please bring the NDOCK to our Agent or Nstore staff so that they can assist you further.

8

LED Problem

LED Problem

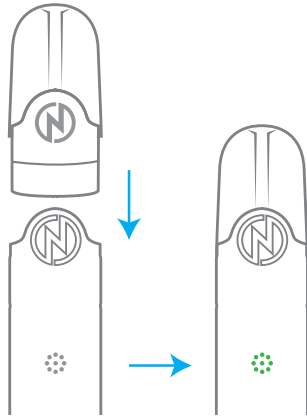

User

Step 1

When you attach the NPOD to the NCIG device, a green light will flash on the LED indicator for 2 seconds.

If NO LED light indication please follow step 3, if YES please proceed with step 2:

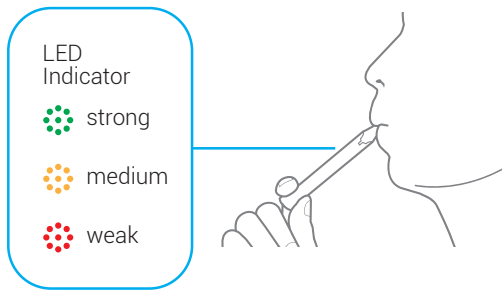

Step 2

When you inhale the NCIG device, various lights will appear on the LED indicator based on the battery status. GREEN: STRONG, ORANGE: MEDIUM and RED: WEAK. If there is NO light indication, please proceed with step 3.

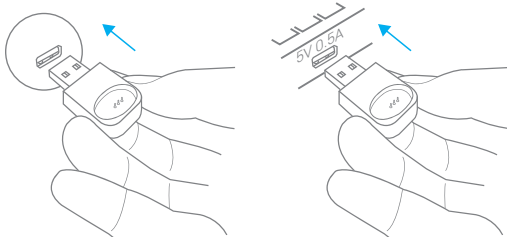

Step 3

Plug the USB Charging Dock into a USB port. A laptop USB port is ideal (5V 0.5A)

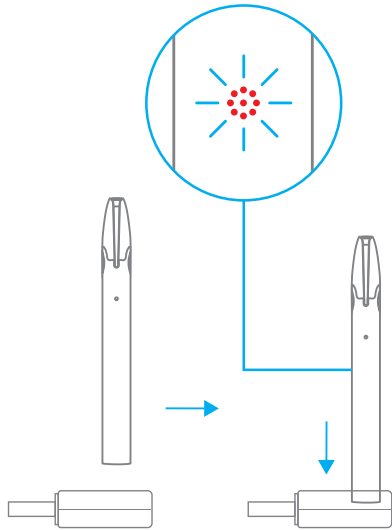

Step 4

Place the NCIG into the NDOCK, and observe the LED indicator. It is supposed to change to a RED flashing color.

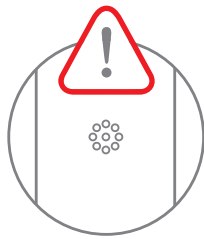

Step 5

If there is still no changes to the LED light indicator of your NCIG Device and is still within the warranty period, please submit a warranty claim for a device replacement.

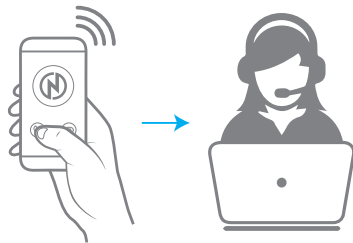

Step 6

Please report to our customer service. Proceed with your details and information, and save your ticket number.

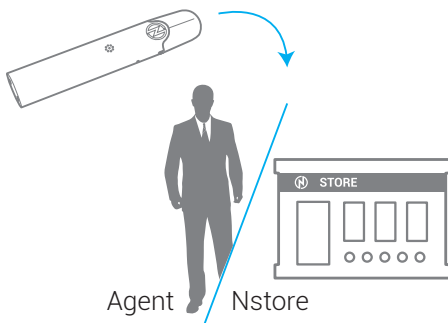

Step 7

Please bring all purchased items to our Agent or Nstore staff so that they can assist you further.

11

Cleaning

Cleaning

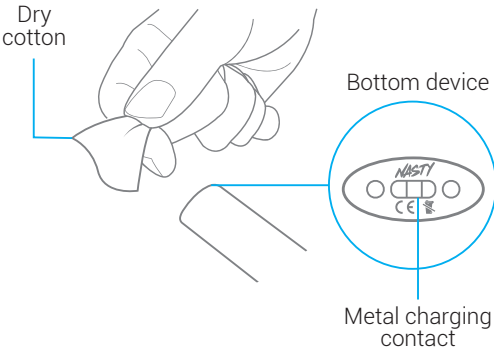

Use a dry cotton swab to gently clean the charge contacts of your NCIG device. During cleaning, user should notice some balance of liquid.

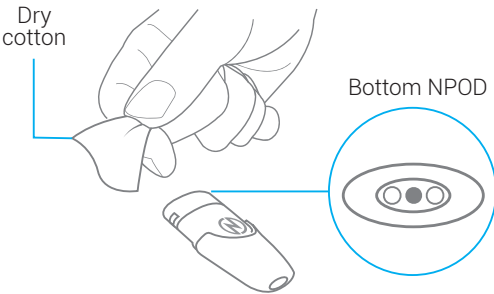

Please clean this remaining liquid as it may affect the performance of the device.

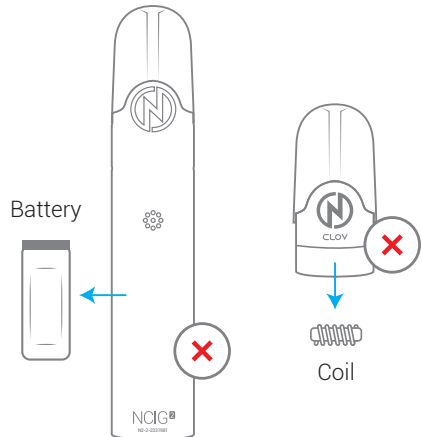

Please do not dismantle the battery in the NCIG device or the coil in the NPOD. Take note, we will void any warranty claim if we found any dismantling activity done by our customer

13

Leaking

Leaking (Internal)
Leaking (External)

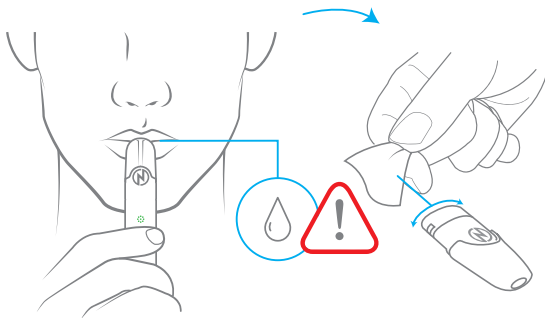

User

Step 1

If there is a taste of leaked liquid inside your mouth, please remove the NPOD and wipe off the liquid before attaching it back into the device. Leakage is common but it should not continuously leak during regular use.

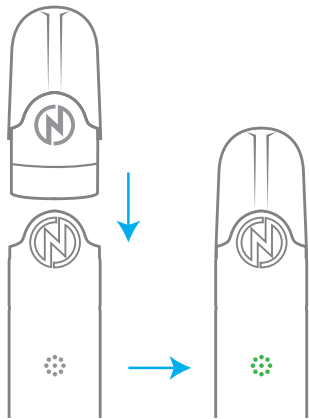

Step 2

Attach the NPOD into your NCIG device and a green light should appear on the LED indicator for 2 seconds. Inhale and observe if there is any taste of leaked liquid inside your mouth.

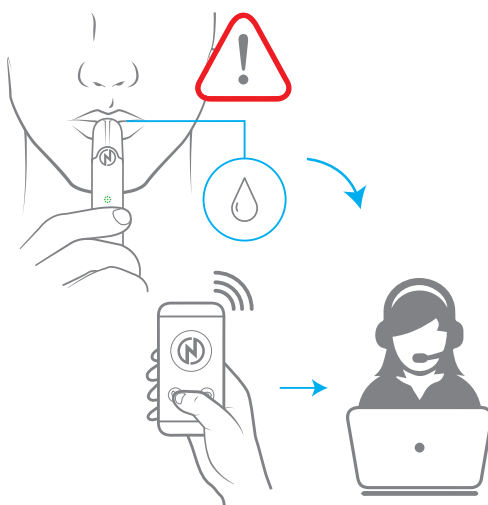

Step 3

If the problem still persists, please report to our customer service. Proceed with your details and information, and save your ticket number.

Please bring together Packaging (2pod or 4 pod) during meeting session with Agent

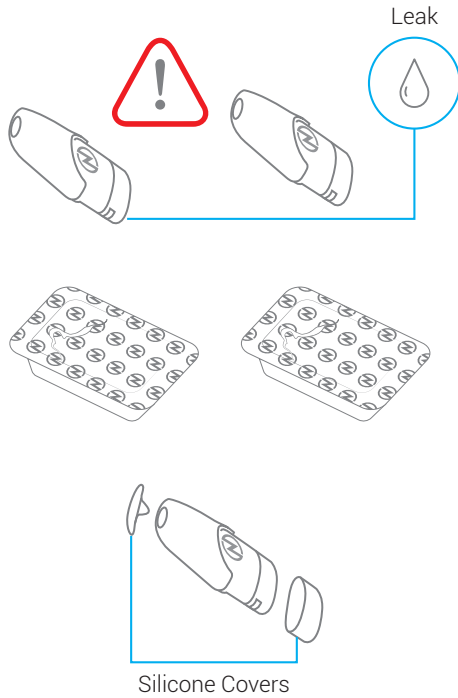

User

Unfortunately, sometimes leakage could be found when customers take out the NPODs from the capsule blister.

This unlikely case might occur if 2 silicone covers are not properly installed during its manufacturing process, or due to transportation issuance.

This rare condition will only happen at random and not by batches.

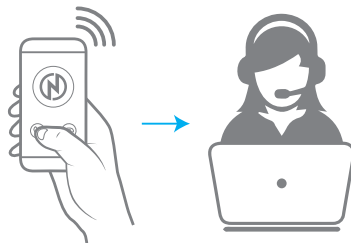

If you encounter this problem, please report to our customer service. Proceed with your details and information, and save your ticket number.

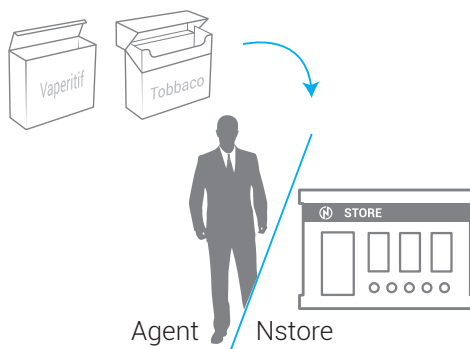

Please bring together the packaging (2 pod or 4 pod) for Agent or Nstore staff to conduct an investigation and report to the manufacturer.

16

Burning Sensation

Burning Sensation

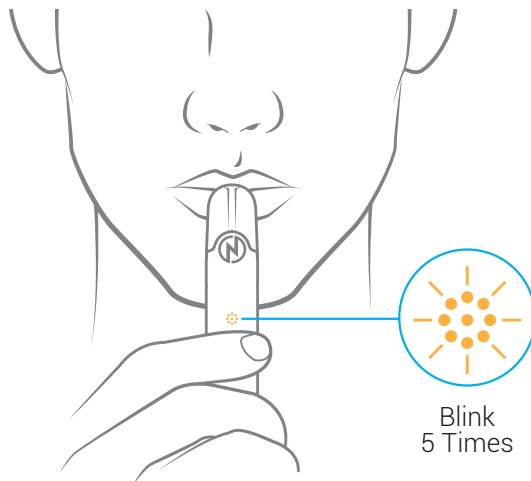

User

Taste is subjective to people but a burning sensation might indicate a defect on a product.

A number of factors may contribute to this issue but it is typically due to the uneven liquid flow in NPODs.

Our NCIG is designed with a dry-burning protection which is triggered when there's insufficient liquid at the coiling and cotton. An orange colour LED will flash for 5 times and the device will shut off.

To ensure liquid, coiling and cotton are well balanced:



Step 1

Make sure you use your NCIG device in the correct position and angle, to avoid leaking.

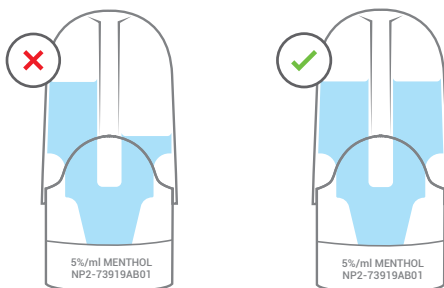

Step 2

Always check that the liquid in your NPODs are leveled.

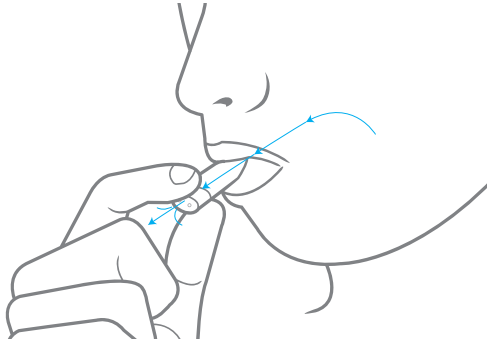

Step 3

Before vaping, please check that your NPODs are in good condition to ensure smooth liquid flow.

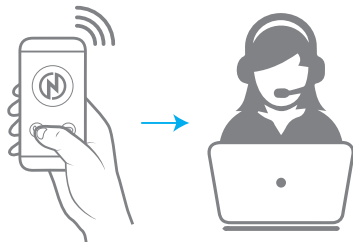

Step 4

If the problem still persists, please report to our CS below. Proceed with your details and information, and save your ticket number.

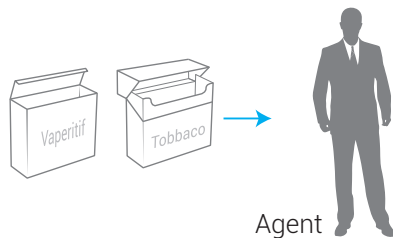

Please bring together Packaging (2pod or 4 pod) during meeting session with Agent

19

Charge NCASE

Charge NCASE

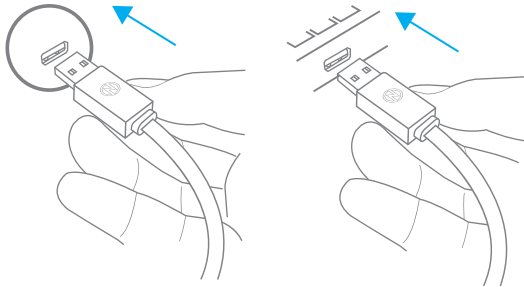

Step 1

Plug the USB cable into a USB port. A laptop USB port is ideal (5V 0.5A)

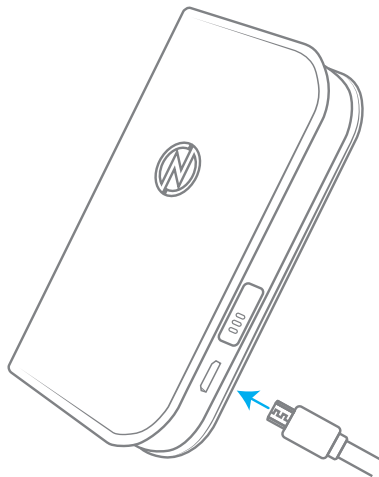

Step 2

Insert the Cable into the NCASE, once cable is connected, the screen will display the battery status by various indicators:



If 3 green lights on
60%-100% power



If 2 green lights on
30%-59% power



If 1 green light on
1%-29% power

NCASE is fully charged when all 3 green lights appear.

21

Can't Charge NCASE

Can't Charge NCASE

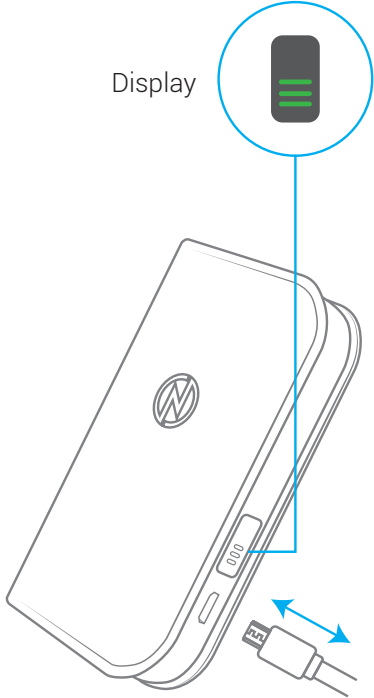

Display

User

When your NCASE Device is charging, the screen will display the battery status by various light indicators.

Step 1

Plug in and Plug out the NCASE device to see if it makes a clear connection to the USB Cable

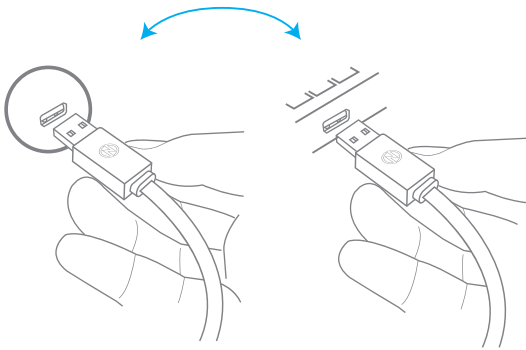

Step 2

Switch to a different power source, either a USB wall adapter or a laptop USB port.

The cable provided with the NCASE device is a common one that is widely available in the market for phones. Please try charging using this common phone cable.

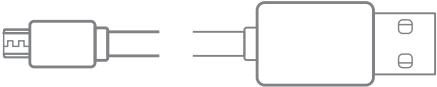

Micro USB Cable



Step 3
If your NCASE Device is still not charging (no change in LED indicator) and is within the warranty period, please submit a warranty claim for a device replacement.

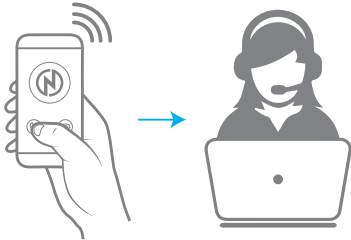

Step 4
Please report to our CS below. Proceed with your details and information, and save your ticket number.

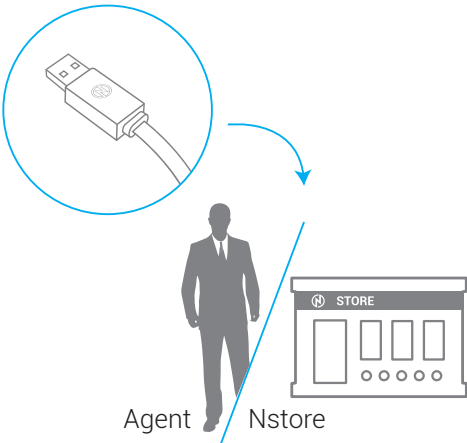

Step 5
Please bring the cable to our Agent or Nstore staff so that they can assist you further.